

Potential-controlled chromatography for the separation of amino acids and peptides

F. KOCAK, K. VUORILEHTO, J. SCHRADER and D. SELL*

Karl-Winnacker-Institute of DECHEMA e.V., Theodor-Heuss-Allee 25, 60486, Frankfurt am Main, Germany

(*author for correspondence, e-mail: sell@dechema.de)

Received 22 March 2005; accepted in revised form 27 July 2005

Key words: amino acids, electrically conductive stationary phase, peptides, potential-controlled chromatography

Abstract

Potential-controlled chromatography is introduced as a new technique for the separation of amino acids and peptides. The principle of potential-controlled chromatography depends on the use of electrically conductive material as the stationary phase of the chromatographic column. Thus from an electrochemical point of view the packed column can be regarded as a packed-bed electrode. The electrical potential of this stationary phase can be controlled by a potentiostat. The separation of amino acid and peptide molecules during their migration through the column depends on their own electric charge on the one hand and on the electrical potential of the stationary phase on the other. The chromatographic separation of some amino acids could be demonstrated.

1. Introduction

Chromatographic processes find widespread application in the recovery of bioproducts. Examples of the isolation of different products range from laboratory scale (micrograms to grams) to industrial scale (several tons per year) [1].

Currently there is considerable interest in the preparative applications of liquid chromatography even though chromatography is often considered to be too expensive. Much research is being undertaken to make chromatography more attractive. On the one hand, investigations are focusing on the optimization of separation processes in order to minimize eluent consumption and to maximize productivity [2]. On the other hand, considerable efforts are also being made to develop new chromatographic separation principles [3, 4]. The work presented belongs to the latter group of research activities.

The principle of potential-controlled chromatography is somewhat related to ion-exchange chromatography: the separation of molecules depends on their own electric charge and on that of the stationary chromatographic phase. For the separation technique reported here, a stationary phase was selected which is electrically conductive, thus from an electrochemical point of view the packed column can be regarded as a packed-bed electrode. The electrical potential of this stationary phase can be controlled by a potentiostat. The use of charge-controllable stationary phases for chromatographic purposes has been discussed in the literature,

especially by Deinhammer et al. [5–7]. In principle a column with such a stationary phase can be used either for cation- or anion-exchange applications, depending on the electrode potential selected. The principle of potential-controlled chromatography is illustrated in Figure 1.

In contrast to classical ion-exchange chromatography the electrical charge of the stationary chromatographic phase does not depend on immobilized charge carriers but on an adjustable abundance or a deficiency of electrons within the stationary phase itself. This opens up the possibility of determining the chromatographic properties of a packed column very precisely via the applied potential and furthermore permits a defined modification of these properties within a separation procedure, as could be demonstrated for the separation of short-chain carboxylic acids [8]. This last item makes potential-controlled chromatography rather a unique technique and opens up new perspectives for the separation of biomolecules.

2. Experimental

2.1. Reagents and materials

All reagents were analytical reagent grade (p.a.) and obtained from Fluka unless otherwise stated. Aqueous solutions were prepared with purified water from a Seralpur UF System (Seral, Germany). Glassy carbon spheres (Sigradur® G) for the stationary phase were

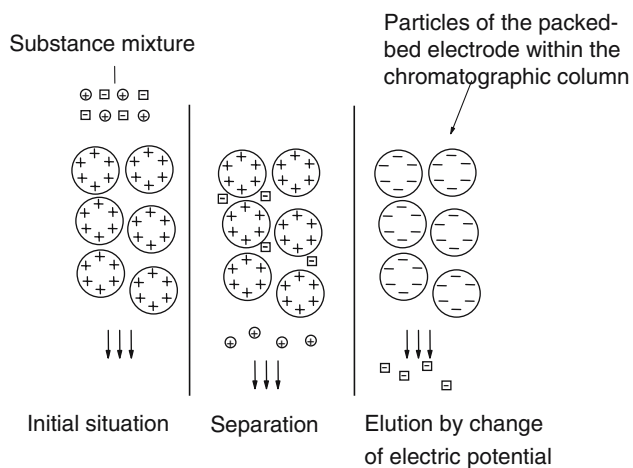

Fig. 1. Theoretical principle of potential-controlled chromatography.

obtained from HTW Hochtemperatur-Werkstoffe GmbH (Germany). All samples for injection were prepared by dissolving the analytes in pure water (see Section 2.3).

2.2. Chromatographic column

A chromatographic column was constructed for the experiments (a cross-section is shown in Figure 2). The column, which from an electrochemical point of view can be regarded as a three-electrode arrangement, consisted of three components connected by screws, their contact surfaces sealed by non-conducting Viton rubber seals. The two external sheets were made of acrylic glass and have rectangular recesses that act as chambers for the counter-electrode electrolyte which was identical to the mobile chromatographic phase (see Section 2.3). The counter-electrodes were platinized titanium grids (Permascand AB, Sweden), separated from the working electrode compartment (stationary phase) by cation-exchange membranes (Ionac-MC3470). The central stainless steel sheet (alloy 316i) was milled through to serve as the actual column for the stationary

phase. This stainless steel plate also represents the electrical contact for the packed stationary phase which consisted of glassy carbon spheres, \varnothing 10–20 μm . The total volume of the bed for the stationary phase in the column was 10 cm^3 . To control the applied potentials a reference electrode (Ag/AgCl/sat. KCl, custom-made by Kurt-Schwabe-Institut, Meinsberg, Germany) was used and was positioned in a small container at the upper side of one counter-electrode chamber. The electrolyte contact was made through a drill hole to the counter-electrode compartment. To prevent loss of electrolyte due to the pressure inside this arrangement an ion-exchange membrane was mounted inside the drilling.

The column packing procedure was carried out using a filling device in which the methanol suspension of glassy carbon particles was filled and then pressed and condensed in the column chamber by means of an HPLC pump (Knauer HPLC pump, type 64, Germany).

2.3. Experimental procedure

The packed column was connected to the potentiostat as a three-electrode cell and fitted into a HPLC system (Figure 3).

The chromatographic experiments were carried out with deaerated phosphate buffer (pH 7.5, 1 mM) as the mobile phase at a flow rate of 1 ml min^{-1} . Chromatographic experiments were started by injecting the samples. The amino acids lysine, histidine, arginine and glutamic acid and a dipeptide of two molecules of glutamic acid were selected as test substances. From each substance a 1 mM solution in pure water was prepared and used for injection. In mixtures of the sample substances, the concentration of each substance was also 1 mM.

2.4. Equipment

The chromatographic equipment consisted of a Shimadzu HPLC system (Japan): controller (SCL-10Avp),

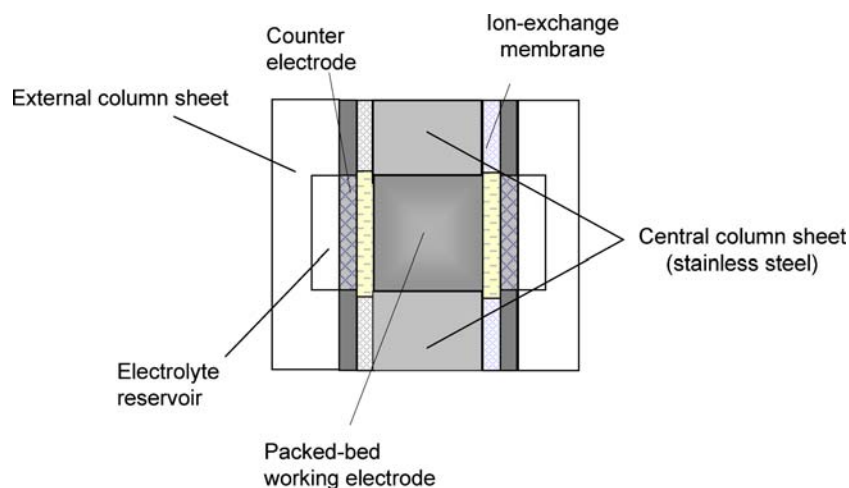

Fig. 2. Cross-section view of the column for potential-controlled chromatography. In the centre is the packed bed of graphite particles, which is contacted by the stainless steel housing and acts as the working electrode. Two counter-electrodes are fixed in the external column sheets.

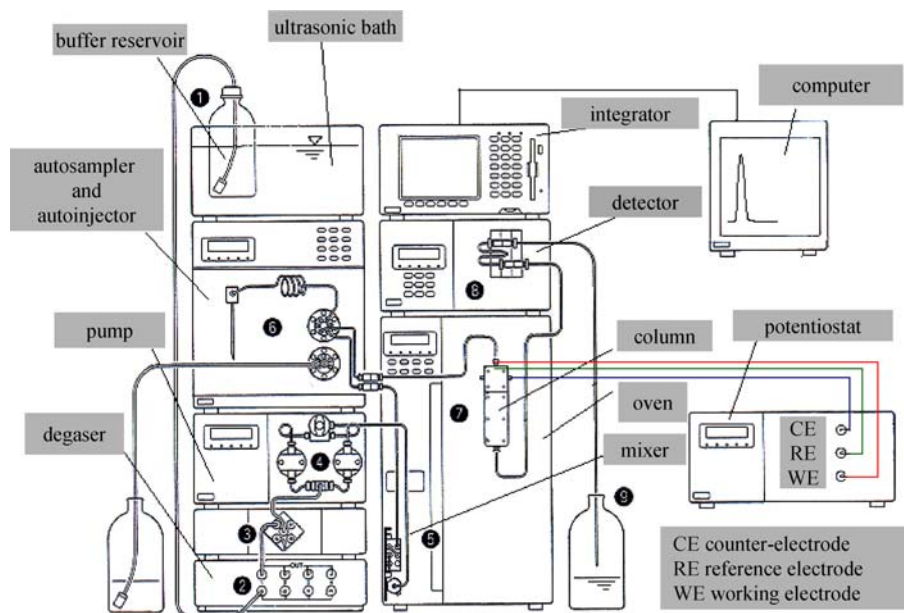

Fig. 3. Experimental set-up for potential-controlled chromatography.

pump (LC-10Advp), auto-injector (SIL-10Advp), valves (FCU-12AH), oven (CTO-10Avp) and detector (SPD-M10AVP photodiode array). The detector was operated between 200–300 nm at 0.2 s collection intervals and was used for detecting and identifying the components by UV absorbance spectra. Collection and processing of the data was carried out with Shimadzu software CLASS-LC10. The voltage applied to the stationary phase was controlled by a Wenking PGS 81R potentiostat (Germany).

3. Results and discussion

3.1. Electrochemical characterisation of the chromatographic equipment

Different materials were screened for application as a stationary phase (data not shown). From among these, Sigradur G particles were selected because they fulfilled most of the demands made of a satisfactory electrode material for a chromatographic system:

- electrical conductivity
- electrochemical stability over a wide potential range
- pressure resistance
- chemical inertia.

The electrochemical characterisation of the chromatographic column was performed by cyclic voltammetry of the packed column.

Figure 4 shows a cyclic voltammogram (scan rate: 1 mV s^{-1}) of the column, packed with Sigradur G particles (diameter 10–20 μm) in phosphate buffer, pH 7.5 (0.1 mol l^{-1}). The voltammogram of the empty column is also shown in the figure.

Between a potential of -600 and $+800 \text{ mV}$ (vs. Ag/AgCl) only a typically small capacitive current for the

charge transfer of the electrochemical double layer can be observed, but there is no sign of a reaction from the electrode material itself.

Above a potential of 1000 mV a steep current increase is observed which is due to the beginning of oxygen formation at the electrode; correspondingly at a negative potential of approx. -700 mV the current increases due to the beginning of hydrogen formation at the electrode surface. The working area selected for the potential-controlled chromatography column was, therefore, between -600 and $+800 \text{ mV}$ (vs. Ag/AgCl).

Cyclic voltammograms were recorded for all test substances, which had been previously dissolved in phosphate buffer, in order to test possible electrochemical reactions within the chosen voltage area – none of the test substances showed any undesired reactions in

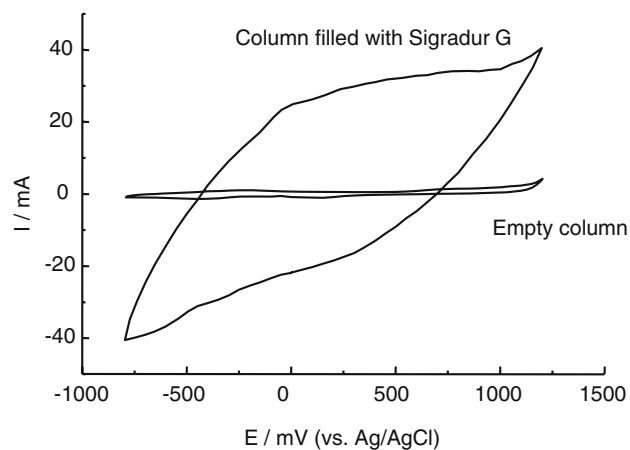

Fig. 4. Cyclic voltammogram of the empty and packed column (Sigradur G particles). The working area for the column was chosen in the potential range -600 to $+800 \text{ mV}$ (vs. Ag/AgCl).

these experiments and the cyclic voltammograms were similar to that shown in Figure 4.

3.2. Potential-dependent retention behaviour of different amino acids

Arginine, glutamic acid and histidine were selected as test substances with different molecular characteristics: at the chosen pH arginine has a positive charge because its basic side chain is protonated, glutamic acid with its acidic side chain has a negative charge, whereas histidine is not charged at all at pH 7.5. The retention behaviour of these three amino acids was studied at different potential values from -600 to $+600$ mV (vs. Ag/AgCl) in three separate test series. The results are shown in Figure 5.

The time that the amino acid arginine needs to pass through the chromatographic column rises with a decrease in column potential towards negative values: at a column potential of $+600$ mV the retention time was 4.4 min, at a potential of -400 mV it increased to 6.4 min. For arginine there was a linear relationship between column potential and retention time.

Glutamic acid could also be influenced with regard to its migration time via the applied column potential. On account of the negative charge of the molecule, the time increased with a rising potential value. In the potential range of -600 to 0 mV there was only a slight increase from 4.7 min to 4.9 min; between 0 mV and $+600$ mV there was a steeper increase from 4.9 min up to 5.6 min. The migration time of histidine was only influenced at negative potential values < -200 mV; at a potential of -400 mV the retention time was 6.3 min, whereas it remained at approx. 5.8 min at all higher potential values tested.

3.2.1. Separation of a two-amino acid mixture

In further experiments the retention times of lysine and glutamic acid, applied as an equimolar mixture, were determined at different column potentials. The aim was

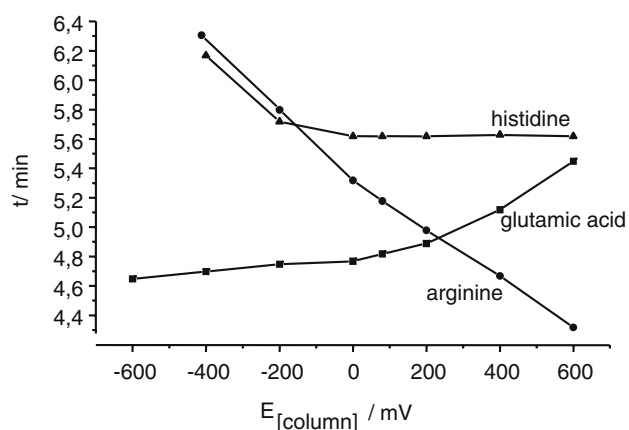

Fig. 5. Retention times (t_r) of histidine, glutamic acid and arginine at different column potentials. All amino acids (1 mM) were tested in phosphate buffer solutions at pH 7.5.

to investigate whether the migration behaviour of the amino acids could be influenced during their passage through the column to permit separation of the two substances.

Experiments with a potential of $+80$ mV (vs. Ag/AgCl, the equilibrium potential of the electrochemical system within the column) showed a retention time of 4.94 min for the two amino acids; both eluted at the same time, forming one peak in the chromatogram (Figure 6a).

In further experiments the column potential was lowered to -400 mV. As shown in Figure 6b, partial separation of the two amino acids was observed in the chromatogram. Whereas the retention time of glutamic acid remained 4.91 min, that of lysine slightly increased to approx. 5.5 min, forming a shoulder in the detected peak.

Complete separation of the two test substances was achieved at a further lowered potential of -500 mV. Figure 6c shows two distinct peaks in the chromatogram, that of glutamic acid again after a retention time of 4.9 min, that of lysine now strongly retarded after 7.65 min. The form of the lysine peak with its marked tailing indicates strong interaction of lysine with the column material. Additional experiments at a further lowered potential showed an increase in the tailing behaviour of the peak; thus the separation of the two amino acids could not be improved in this way.

An improvement in chromatographic behaviour can be achieved if the potential of the column is altered during the separation process, as shown in Figure 6d. In this experiment the potential of the column was set at -600 mV (vs. Ag/AgCl) for a period of 6 min. By this time the glutamic acid peak (4.89 min) had almost declined to the base line, while lysine had not started to leave the column. Then the potential was raised to 600 mV; the lysine peak with a retention time of 8.54 min showed a significantly reduced tailing and the overall chromatographic behaviour improved.

Chromatographic experiments at positive column potentials also resulted in a separation of both the amino acids, as shown in Figure 6e. The separation is not complete, but it is remarkable that the order of the two peaks has reversed: lysine elutes first with an elution time of 4.97 min, glutamic acid elutes approx. 1 min later, after 5.89 min.

Table I summarizes the results presented in Figures 6a–6e; in addition, the capacity factor k for each of the amino acids was calculated. The capacity factor was calculated according to Equation (1)

$$k = \frac{t_r - t_m}{t_m} \quad (1)$$

where c_f is capacity factor, t_r is retention time of a substance, and t_m is time that the mobile phase needs to pass through the column. k is a figure which immediately permits conclusions to be drawn about the retarding of a substance within the column. The ratio of the capacity factors of two individual substances is

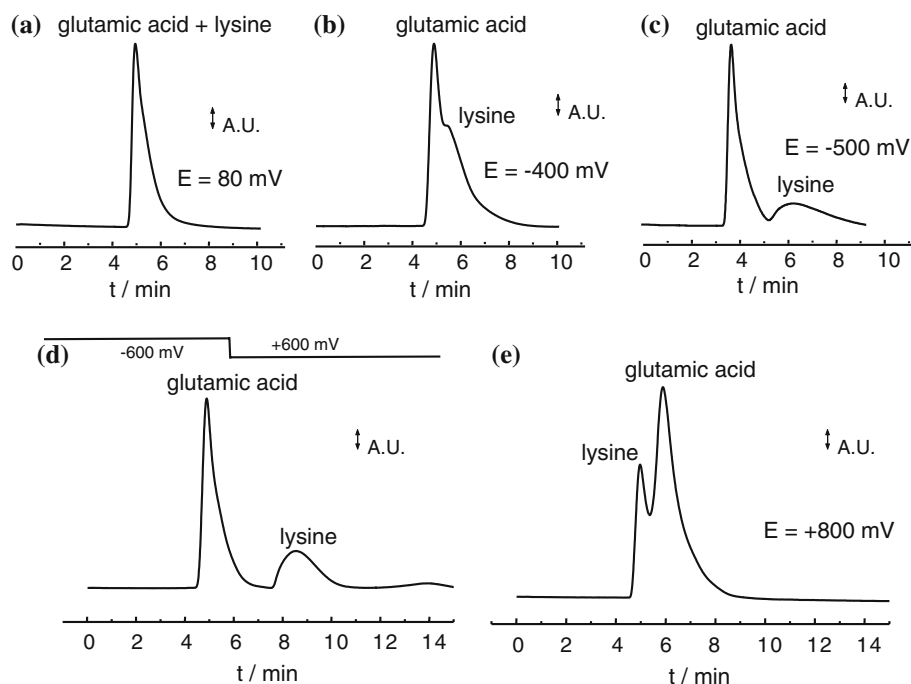

Fig. 6. Chromatographic behaviour of an equimolar mixture of glutamic acid and lysine at: (a) the equilibrium potential of the column (80 mV). (b) a potential of -400 mV. (c) a potential of -500 mV. (d) a potential of -600 mV with a potential step to $+600$ mV after 6 min. (e) a potential of $+800$ mV. All potential values measured vs. an AG/AgCl reference electrode.

called the separation factor, α , which is also listed for the different experiments in Table 1. The separation factor, α , was calculated according to Equation (2).

$$\alpha = \frac{k_2}{k_1} \quad (k_2 > k_1) \quad (2)$$

Figure 6a–e and Table 1 clearly show that the positively charged amino acid lysine can be influenced with regard to its retention times when the column is charged negatively. The influence grows stronger in proportion to the increase in negative potential. As expected, the migration behaviour of glutamic acid was not influenced at negative potentials because the molecule itself is charged negatively.

The improvement observed in the separation of the two amino acids is obvious when considering the capacity and separation factors. These factors show that the best separation can be achieved at negative column potentials (or in combination with a potential step to a positive column potential). This indicates that

lysine undergoes stronger retardation/interaction at negative column potentials than glutamic acid at positive column potentials. Nevertheless it can be seen that potential-controlled chromatography offers many new perspectives: anion or cation-specific chromatography can be performed within the same column and, as shown in the first experiments, the properties of the column material can be altered within the separation procedure.

3.3. Potential-dependent retention behaviour of a Glu–Glu-dipeptide

Further chromatographic experiments were carried out with dipeptides of two molecules of glutamic acid (glu–glu). The aim was to investigate if and, if so, how this larger molecule with different intramolecular charge density and charge distribution would behave in a potential-controlled chromatographic column. The peptide showed a significantly higher interaction with the solid phase of the chromatographic column than its

Table 1.

Column potential U /mV	Glutamic acid		Lysine		Separation factor α
	Retention time, t_r /min	Capacity factor k	Retention time, t_r /min	Capacity factor k	
-500	4.9	0.089	7.65	0.7	7.9
-400	4.91	0.091	5.54	0.231	2.54
$80 (U_R)$	4.94	0.098	4.94	0.098	1
$+800$	5.89	0.31	4.97	0.104	2.98
$-600 \rightarrow +600$	4.89	0.087	8.54	0.898	10.32

monomer glutamic acid. At negative column potentials glutamic acid and its dimer still showed similar retention times, but between 0 mV and 200 mV the retention time of glu–glu increased steeply; at potential values > 200 mV the dipeptide remained within the chromatographic column and was completely adsorbed on the surface of the stationary phase. To illustrate this phenomenon Figure 7 shows the course of the capacity factors for glutamic acid and its dimer over the potential range –600 mV to +600 mV. The broken line for glu–glu indicates that this substance has remained in the column.

The complete adsorption of the dipeptide was proved by a further experiment: a sample of the substance was injected into the chromatographic system when the column potential was set at +300 mV. As expected, no substance peak eluted from the column. After 24 min the column potential was shifted to –300 mV. As a result, the dipeptide eluted in a sharp peak after 38 min (Figure 8).

The peak fraction was analysed by thin-layer chromatography with subsequent ninhydrin staining and revealed the eluting substance to be the injected peptide.

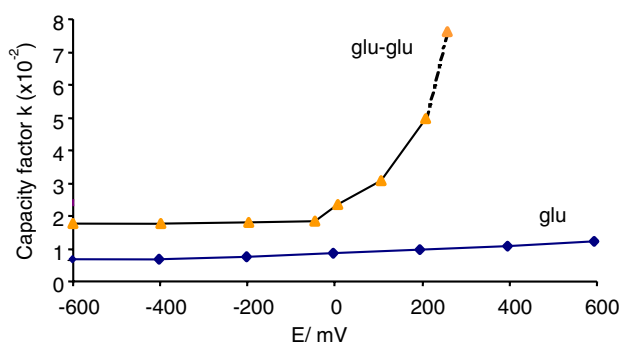

Fig. 7. Dependence of capacity factor k on column potential E for glutamic acid and a dipeptide of two molecules of glutamic acid.

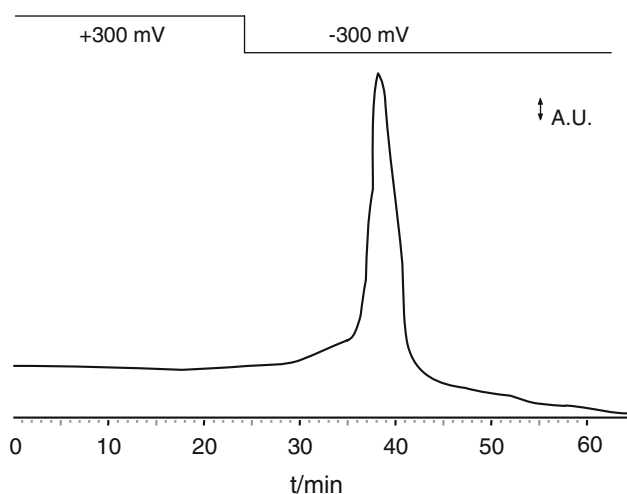

Fig. 8. Chromatographic behaviour of the dipeptide glu–glu at an initial potential of 300 mV with a potential step to –300 mV (vs. Ag/AgCl) after 24 min.

4. Conclusions

Effective separation techniques are the key to commercial success in disciplines that deal with complex matrices, as in the field of biotechnology. Potential-controlled chromatography has proved to be a suitable instrument for the separation of amino acids and peptides, which are typical biotechnological products. The separation of a product from a fermentation broth can account for up to 80% of the whole production costs [9]. For this reason, there is a steady demand for new and appropriate separation techniques in that field [10]. Apart from the field of downstream processing, potential-controlled chromatography could find further application in proteome analysis, where a fast, continuous separation system for amino acids, peptides and proteins is needed [11].

The separation principle of potential-controlled chromatography can be regarded as similar to that of conventional ion-exchange chromatography, but the striking difference is that the properties of the stationary phase can be altered during a chromatographic separation process by changing its electrical polarisation. This fact opens up many new perspectives: thus it appears to be possible to use a column with an electrically conductive phase for either anion-exchange or cation-exchange chromatography, depending on the potential values applied. The material used for the stationary phase fulfils another requirement, particularly of the pharmaceutical branch of biotechnology [12]: it is steam-sterilizable in accordance with GMP requirements (and may well be the first chromatographic material to meet them). Other materials such as electrically conductive polymers, which may also be suitable for the application of potential-controlled chromatography and which have been widely investigated for further electrochemical application [13–15], may also satisfy this need.

Thus, we consider potential-controlled chromatography to be a promising new tool for the separation of biomolecules. Further investigations will address scale-up for preparative applications.

Acknowledgement

This research (No. 9968N) was supported by Arbeitsgemeinschaft industrieller Forschungsvereinigungen e.V. through the German Federal Ministry of Economics and Labour.

References

1. A. Lyddiatt, *Curr. Opin. Biotechnol.* **13**(2) (2002) 95–103.
2. A. Uretschläger and A. Jungbauer, *Separ. Sci. Technol.* **37**(7) (2002) 1683–1697.
3. R. Hahn, E. Berger, K. Pfliegerl and A. Jungbauer, *Anal. Chem.* **75**(3) (2003) 543.

4. R.A. Keller, *Analytical Chemistry* (Wiley-VCH, Weinheim, 1998).
5. R.S. Deinhammer, K. Shimazu and M.D. Porter, *Anal. Chem.* **63** (1991) 1889.
6. R.S. Deinhammer, E.Y. Ting and M.D. Porter, *J. Electroanal. Chem.* **362** (1993) 295.
7. R.S. Deinhammer, M.D. Porter and K. Shimazu, *J. Electroanal. Chem.* **387** (1995) 35.
8. M.W. Knizia, K. Vuorilehto, J. Schrader and D. Sell, *Electroanalysis* **15**(1) (2003) 49.
9. W. Storhas, *Bioverfahrensentwicklung* (Wiley-VCH, Weinheim, 2003).
10. E. Goldberg (ed.), *Handbook of Downstream Processing* (Blackie Academic and Professional, London, 1996).
11. K.D. Kumble, *Anal. Bioanal. Chem.* **377**(5) (2003) 812.
12. G. Schmidt-Kastner and D. Sell, *Recovery of Bioproducts* (SCI, London, 1993).
13. H. Ge and G.G. Wallace, *Anal. Chem.* **61** (1989) 2391.
14. T. Nagaoka, M. Fujimoto, H. Nakao, K. Kahuno, J. Yano and K. Ogura, *J. Electroanal. Chem.* **64** (1994) 179.
15. T. Nagaoka, M. Fujimoto, H. Nakao, K. Kahuno, J. Yano and K. Ogura, *J. Electroanal. Chem.* **350** (1993) 337.